

WARNING! - Please Read this Information Carefully:

The project described in these pages utilizes **POTENTIALLY FATAL HIGH VOLTAGES**. If you are in any way unfamiliar with high voltage circuits or are uncomfortable working around high voltages, **PLEASE DO NOT RISK YOUR LIFE BY BUILDING THEM**. Seek help from a competent technician before building any unfamiliar electronics circuit. While efforts are made to ensure accuracy of these circuits, no guarantee is provided, of any kind!

***USE AT YOUR OWN RISK:* THE WEBMASTER, PROJECT COORDINATOR, PROJECT CONTRIBUTORS AND WEB SPACE PROVIDER EXPRESSLY DISCLAIM ALL LIABILITY FOR INJURY OR PROPERTY DAMAGE RESULTING FROM THIS INFORMATION! ALL INFORMATION IS PROVIDED 'AS-IS' AND WITHOUT WARRANTY OF ANY KIND.**

COPYRIGHT AND INTELLECTUAL PROPERTY NOTICE:

The content of this document is protected by the copyright laws of the United States of America and the international copyright laws and agreements.

Except where specifically noted, Cliff Chappell or Chris Hurley owns (or has permission to use) all intellectual property rights in relation to this document and its content (including, but not limited to, all trademarks and copyright).

No part of the document may be reproduced, displayed, copied, translated, adapted, downloaded, broadcast, used or republished in any form including (without limitation) distribution, or storage in a system for retrieval.

CAPACITOR, DIODE, RESISTOR, POT. AND TUBE NUMBERING NOTE:

GAPS HAVE BEEN LEFT IN THE CAPACITOR, DIODE, RESISTOR, POTENTIOMETER, AND TUBE NUMBERING IN ORDER TO MAINTAIN CONSISTENCY BETWEEN THE P1, HIGH OCTANE, AND P1 EXTREME AMPS. A MISSING COMPONENT INDICATES THAT IT IS NOT USED ON THAT AMP, BUT IS USED ON ANOTHER.

RADIO NOISE NOTE:

IN THE UNLIKELY EVENT YOUR AMP STARTS PICKING UP RADIO STATIONS, YOU CAN INSTALL A GRID RESISTOR ON PIN 7 OF V4B. THE VALUE SHOULD BE BETWEEN 10K AND 68K. THE HIGHER THE VALUE, THE LESS RADIO NOISE AND THE LOWER THE VALUE, THE LESS POWER SUPPLY NOISE.

Revision	Description
08.05.07	Cathode Follower Changes
08.07.29	Corrected Value Of R11 On BOM
10.03.18	Added Radial Cap Layout To Documents
10.06.16	Updated Hammond PT Hookup

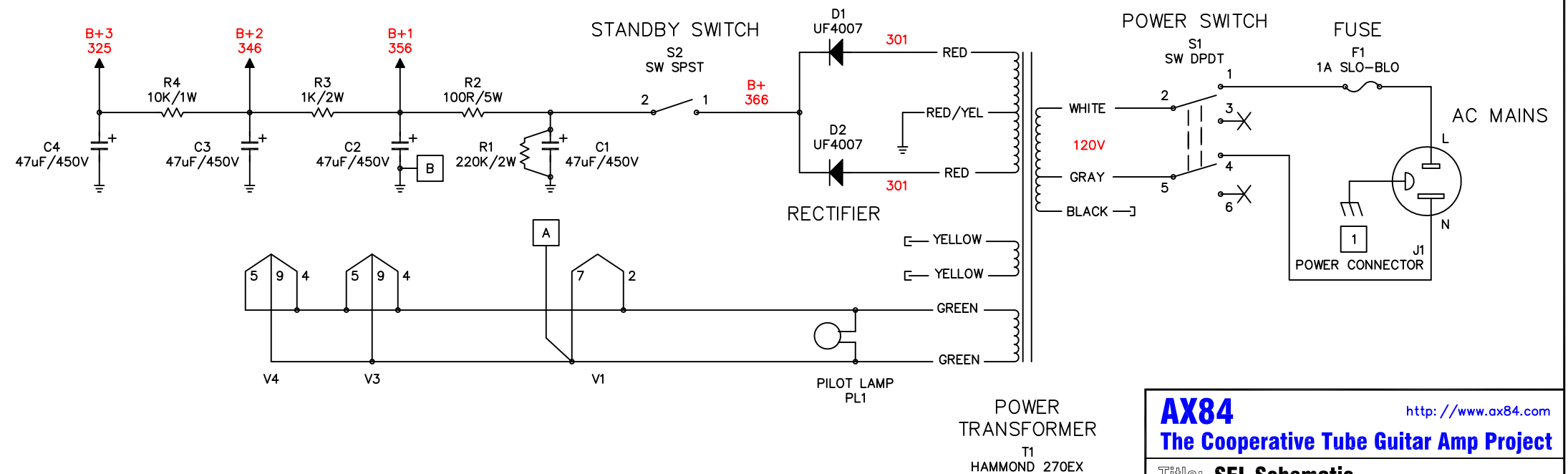
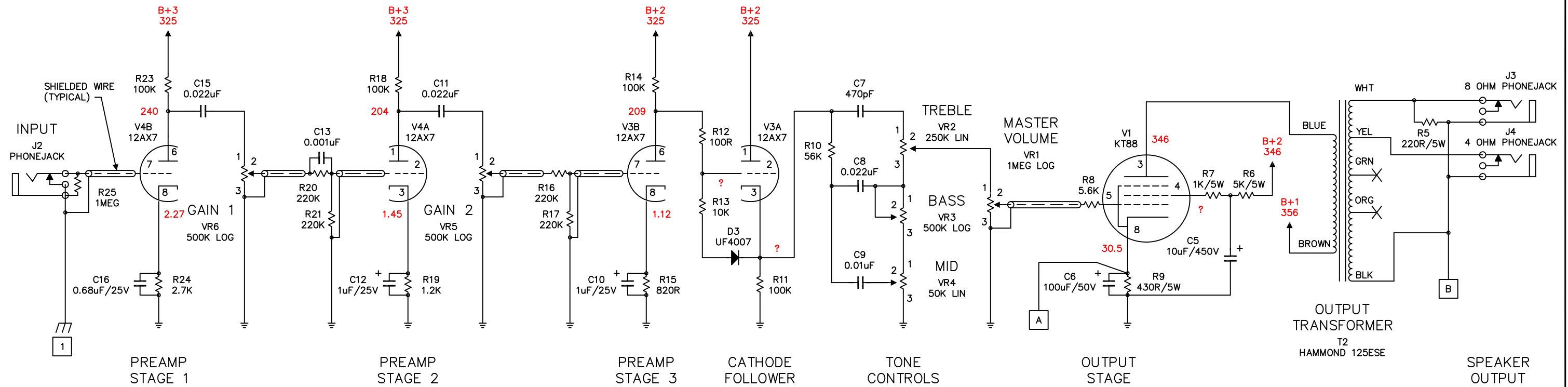

Revision	Description
08.05.07	Cathode Follower Changes
08.07.29	Corrected Value Of R11 On BOM
10.03.18	Added Radial Cap Layout To Documents
10.06.16	Updated Hammond PT Hookup

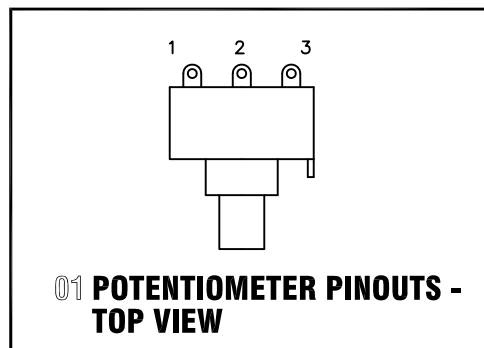

GENERAL NOTES:

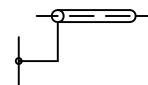
- ALL RESISTORS 1/2W MINIMUM UNLESS OTHERWISE NOTED.
- ALL COUPLING CAPACITORS 400V OR GREATER.
- 47uF/450V ELECTROLYTIC POWER SUPPLY CAPACITOR VALUES/VOLTAGES ARE NOT CRITICAL. SUGGESTED VALUES: 20-50uF AT 450-500V.
- THE HAMMOND 270EX POWER TRANSFORMER IS USED IN THIS AMP. IT MAY BE REPLACED BY UNITS WITH THE FOLLOWING SPECIFICATIONS:
275-0-275V @ 125mA OR MORE SECONDARY B+ TAPS
6.3V @ 4A OR MORE FILAMENT TAPS
- THE HAMMOND 125ESE OUTPUT TRANSFORMER IS USED IN THIS AMP. IT MAY BE REPLACED BY UNITS WITH THE FOLLOWING SPECIFICATIONS:
SINGLE-ENDED OUTPUT
2500 OHM PRIMARY IMPEDENCE
90mA OR MORE MAXIMUM D.C. BIAS
4, 8, AND 16 OHM SECONDARY TAPS
- SHIELDED WIRE, AS WELL AS THE SHIELD'S TIE TO GROUND, IS SHOWN IN THIS MANNER ON THE SCHEMATIC:

- IF YOU HAVE MAINS VOLTAGES OF 200VAC OR ABOVE, YOU SHOULD USE HAMMOND'S 3XX SERIES TRANSFORMERS INSTEAD OF THE 2XX SERIES SHOWN. THE 369EX SHOULD REPLACE THE 269EX, THE 370DX REPLACES THE 270DX, AND THE 370EX REPLACES THE 270EX.

CONSTRUCTION NOTES:

- THIS IS A GROUND CONNECTION TO THE CHASSIS. THE MAINS SAFETY CONNECTION SHOULD BE MADE AS CLOSE AS POSSIBLE TO THE POINT WHERE AC ENTERS THE CHASSIS. THE CIRCUIT CONNECTION SHOULD BE MADE AS CLOSE AS POSSIBLE TO THE INPUT JACK. IDEALLY, THE JACK ITSELF SHOULD BE USED AS THE CONNECTION POINT BY NOT ISOLATING IT FROM THE CHASSIS.

AX84 SEL Amplifier BOM

Revision: 10.03.08

NOTE: Parts for options are not included on this bill of materials.

Item	Quantity	Reference	Value
1	4	C1, C2, C3, C4	47uF/450V
2	1	C5	10uF/450V
3	1	C6	100uF/50V
4	1	C7	470pF
5	3	C8, C11, C15	0.022uF
6	1	C9	0.01uF
7	2	C10, C12	1uF/25V
8	1	C13	0.001uF
9	0	C14	Not Used
10	1	C16	0.68uF/25V
11	1	R1	220K/2W
12	1	R2	100R/5W
13	1	R3	1K/2W
14	1	R4	10K/1W
15	1	R5	220R/5W
16	1	R6	5K/5W
17	1	R7	1K/5W
18	1	R8	5.6K
19	1	R9	430R/5W
20	1	R10	56K
21	4	R11, R14, R18, R23	100K
22	1	R12	100R
23	1	R13	10K
24	1	R15	820R
25	4	R16, R17, R20, R21	220K
26	1	R19	1.2K
27	0	R22	Not Used
28	1	R24	2.7K
29	1	R25	1 Meg
30	1	F1	2A SLO-BLO
31	1	FH1	Fuse Holder
32	1	J1	Power Connector
33	4	J2, J3, J4, J5	Phonejack
34	4	JW1, JW2, JW3, JW4	Phonejack Isolation Washer (if needed)
35	1	S1	SW DPDT
36	1	S2	SW SPST
37	3	D1, D2, D3	UF4007
38	1	PL1	Pilot Lamp Assembly And Bulb
39	1	T1	Hammond 270EX
40	1	T2	Hammond 125ESE
41	2	SK3, SK4	9 Pin Tube Sockets
42	1	SK1	8 Pin Octal Socket
43	1	V1	KT88
44	2	V3, V4	12AX7
45	1	VR1	1Meg LOG

46	1	VR2	250K LIN
47	3	VR3, VR5, VR6	500K LOG
48	1	VR4	50K LIN
49	6	K1, K2, K3, K4, K5, K6	Knobs
50	1	CH1	Chassis

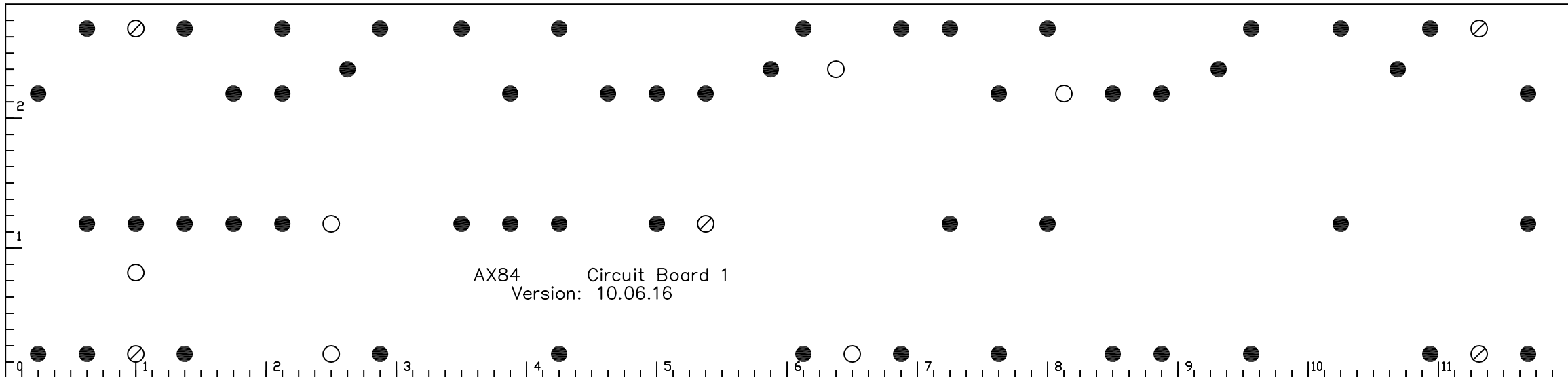

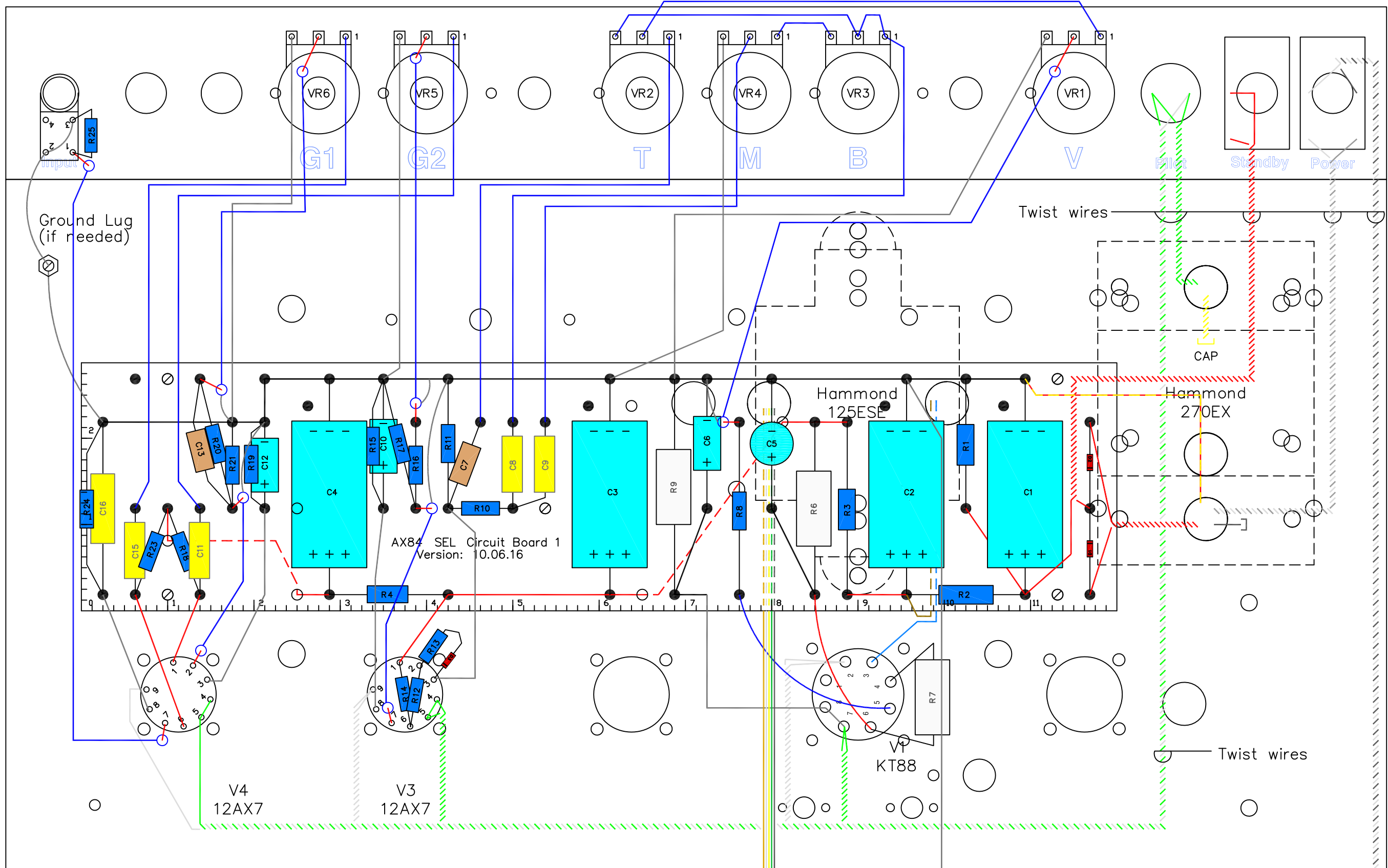

AX84 SEL Chassis Layout (Axial Caps)

Version: 10.06.16

AX84 Kit Chassis 1

Version: 08.05.07

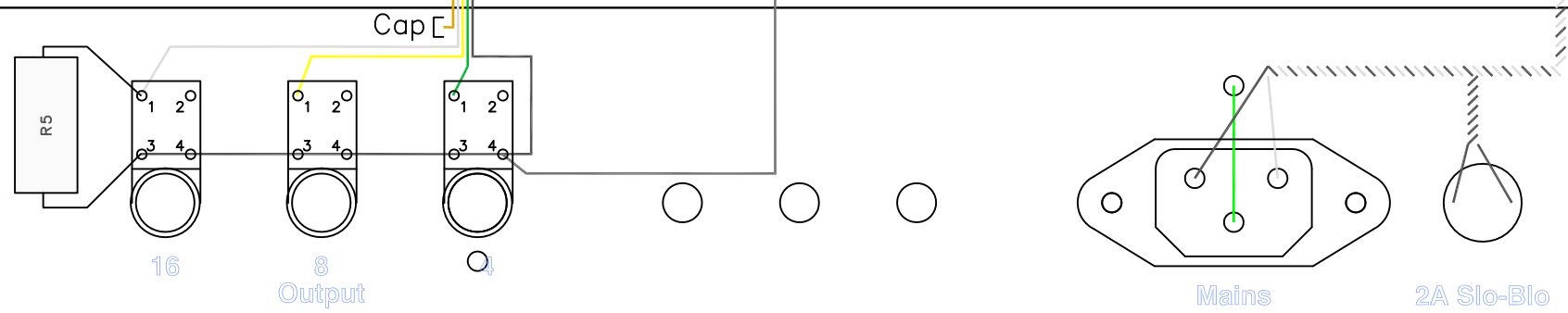

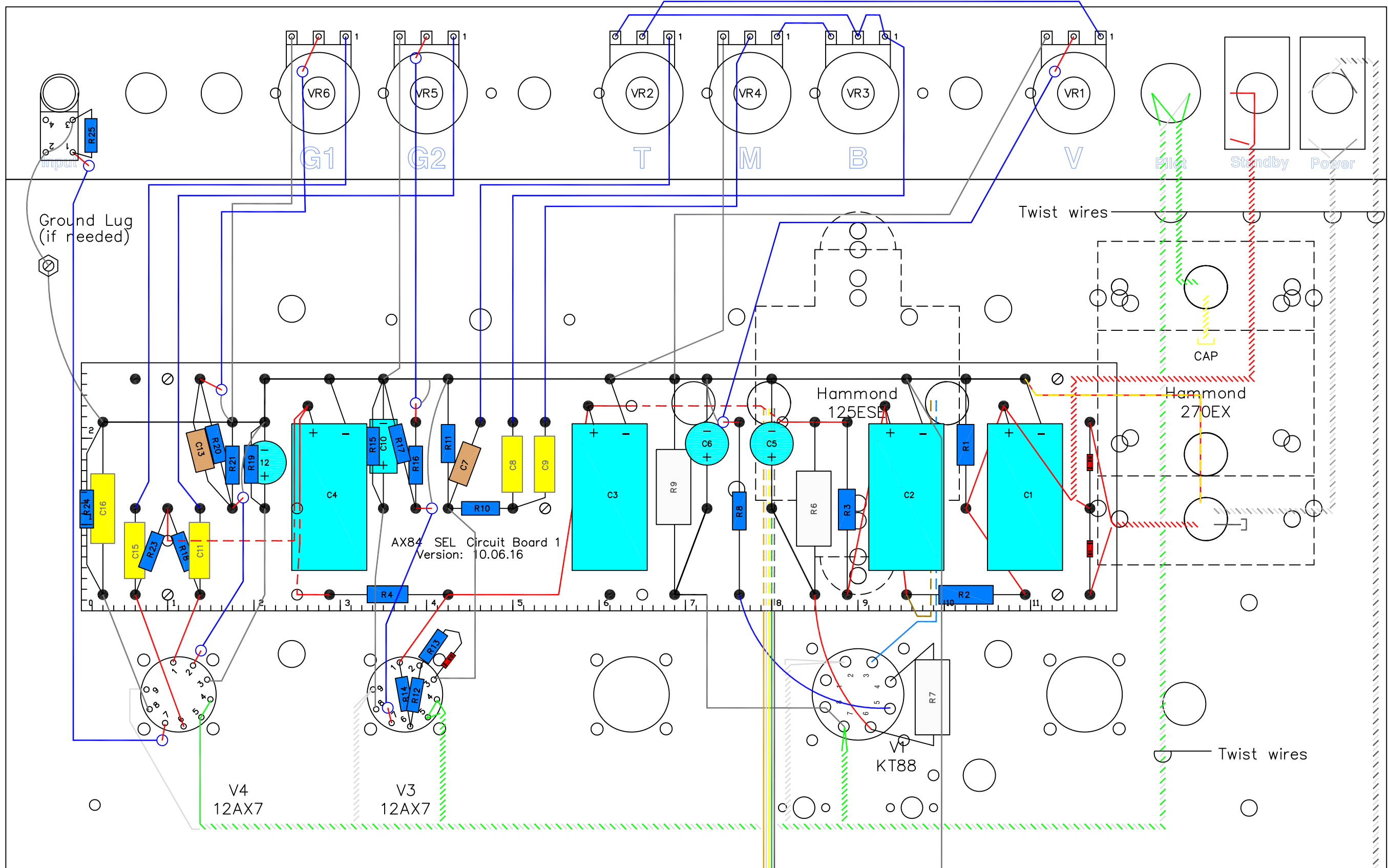

AX84 SEL Chassis Layout (Radial Caps)

Version: 10.06.16

AX84 Kit Chassis 1

Version: 08.05.07

